









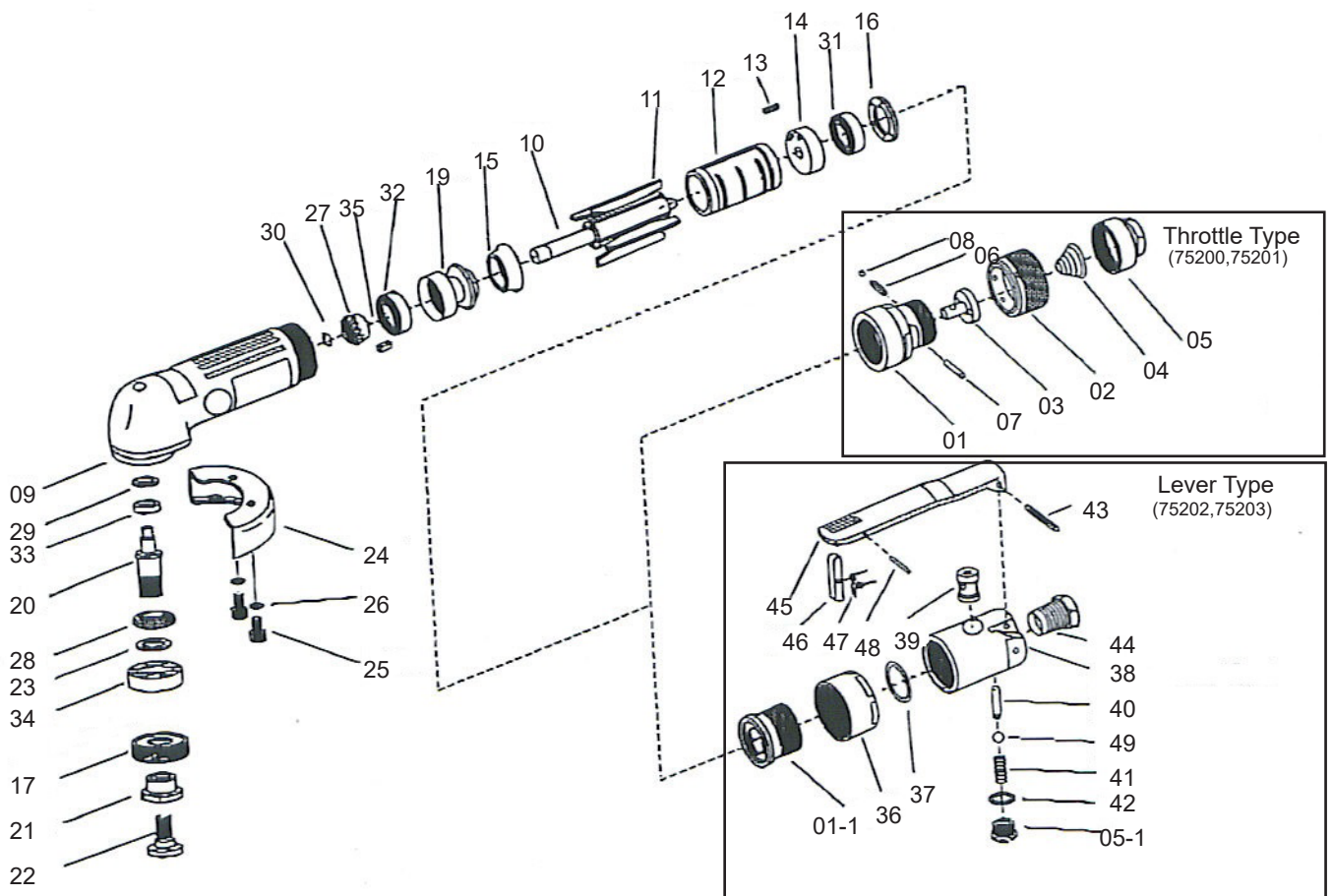

Technische Details Technical Details	 min ⁻¹	 wheel mm/in ^{1/2}	 spindle	 kW/HP kW	 mm/in ^{1/2}	 kg/lb	 l/min	 inch ^{1/2}	 m/s ²	 dB (A)	 bar/psi P bar
75200	15.000	50 (2)	1/4-28	0.30(0.4)	157(6.2)	0.6(1.3)	43(1.5)	1/4	-	-	6.3 (90)
75201	15.000	75(3)	1/4-28	0.30(0.4)	157(6.2)	0.6(1.3)	43(1.5)	1/4	-	-	6.3 (90)
75202	15.000	50 (2)	1/4-28	0.30(0.4)	190(7.5)	0.9(2.0)	43(1.5)	1/4	-	-	6.3 (90)
75203	15.000	75(3)	1/4-28	0.30(0.4)	190(7.5)	0.9(2.0)	43(1.5)	1/4	-	-	6.3 (90)



Index No.	Description	Quantity	Index No.	Description	Quantity	Index No.	Description	Quantity
01	Housing Cover(Throttle Type)	1	16	Bearing Cover	1	34	Ball Bearing (6001)	1
01-1	Housing Cover(Lever Type)	1	17	Bearing Cover Spindle	1	35	Key	1
02	Grip	1	19	Bearing Case	1	36	Cup Nut	1
03	Throttle Valve	1	20	Wheel Spindle	1	37	Seal	1
04	Throttle Valve Spring	1	21	Wheel Flange (A)	1	38	Valve Body	1
05	Throttle Valve Cover (Throttle Type)	1	22	Wheel Flange (B)	1	39	Valve Bushing	1
05-1	Throttle Valve Cover (Lever Type)	1	23	Wheel Spindle Washer	1	40	Valve Rod	1
06	Knock Spring	1	24	Wheel Guard	1	41	Valve Spring	1
07	Needle Roller	1	25	Cap Screw	2	42	Seal	1
08	Ball	1	26	Spring Washer	2	43	Spring Pin	1
09	Housing	1	27	Bevel Pinion	1	44	Inlet Bush	1
10	Rotor	1	28	Bevel Gear	1	45	Throttle Valve Lever	1
11	Rotor Blade	4	29	Bearing Washer	1	46	Safety Lock	1
12	Cylinder	1	30	Ring	1	47	Safety Lock Spring	1
13	Spring Pin	1	31	Ball Bearing (606)	1	48	Spring Pin	1
14	Cylinder Upper Plate	1	32	Ball Bearing (608)	1	49	"O" Ring	1
15	Cylinder Lower Plate	1	33	Ball Bearing (605)	1			